



Project \_\_\_\_\_  
 Item # \_\_\_\_\_  
 Quantity \_\_\_\_\_

# Remote Refrigerated Drop-In Wells

Models: CWBR-1, -2, -3, -4, -5, -6  
 CWBX-1, -2, -3, -4, -5, -6

Hatcos Remote Refrigerated Drop-In Wells keep pre-chilled food products at safe serving temperatures but in remote configurations that offer more flexibility in your particular dining design needs. Unique top angled inside wall design allows cold air to effectively blanket your food product to keep the food optimally cold and fresh.

## Standard features

- Top mount unit holds full-size pans in 1- to 6-pan configurations
- NSF 7 approved cold wall construction utilizes R-404A refrigerant keeping food product cold without drying it out
- Auto-defrost is activated through an advanced electronic controller programmed at the customer location
- 1" NPT brass drain simplifies cleaning
- Matches the Hatco line of Wells for a full integrated look
- **CWBR models only:**
  - Include a condensing unit (shipped loose – can be field mounted up to 50' [15.24 meters] of tubing from unit) and control panel (shipped loose – probe wires are 16' [4.9 meters]) for installing in more convenient or desirable locations
- **CWBX models only:**
  - Includes a control panel (shipped loose – probe wires are 16' [4.9 meters]) but without a condensing unit for the increased flexibility of multiple cold well configurations

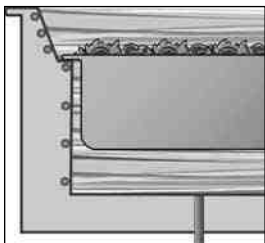

*The unique angled inside wall design provides easy access and clear views. The greater surface area of the angled wall and the placement of the coils allow cold air to more effectively blanket your food product.*

*Remote models consist of these components shipped loose*



*Model CWBR-6 with accessory (hotel) food pans*



*Control panel (Shipped loose)*



*Condensing Unit CWBR with a Condensing Unit CWBX without a Condensing Unit*

## Options (available at time of purchase only)

- Additional Four-Year Parts Only Warranty on the Compressor (CWBR only) at Time of Unit Purchase (Not available for export voltages)
- Slant Kit to give Cold Wells a 5° tilt

## Accessories

### Pan Support Bars

- 12" (305 mm), hangs from 20" (508 mm) Pan Support Bar
- 20" (508 mm), hangs from pan shelf

### Stainless Steel Food Pans:

- Third-Size (2.5" [64 mm] H)
- Full-Size (2.5" [64 mm] H)
- Full-Size (6" [152 mm] H)
- Half-Size (2.5" [64 mm] H)
- Full-Size (4" [101 mm] H)

- False Bottom (perforated false bottom)

### Trivets:

- Half-Size (10.19" [259 mm] W x 7.625" [194 mm] D)
- Full-Size (10.125" [259 mm] W x 18" [457 mm] D)



**HATCO CORPORATION** | P.O. Box 340500 Milwaukee, WI 53234-0500 U.S.A.  
 (800) 558-0607 | (414) 671-6350 | www.hatcocorp.com | support@hatcocorp.com



# Remote Refrigerated Drop-In Wells

Models: CWBR-1, -2, -3, -4, -5, -6, CWBX-1, -2, -3, -4, -5, -6

## Ordering Instructions:

Please specify the following with each order:

### 1. Desired Voltage and Hz:

120 (60 Hz),  
220, 230 or 240V (50 or 60 Hz)

### 2. Number of Drop-In Wells Required:

1-, 2-, 3-, 4-, 5- or 6-pan as rectangular, full-size, 12" x 20", (305 mm x 508 mm)

### 3. Remote Refrigeration

**NOTE:** Shipped loose: Cold Well with Temperature Probe, Control Panel (Probe wires are 16' [4.9 meters]) and a TXV valve

- A. CWBR with a condensing unit - may be field mounted up to 50' (15.24 meters) of tubing from the unit - that is shipped loose (Solenoid Valve attached to Cold Well)
- B. CWBX, Condensing Unit not included (Solenoid Valve attached to Cold Well)

## ALL MODELS - Slant Option (gray highlight)

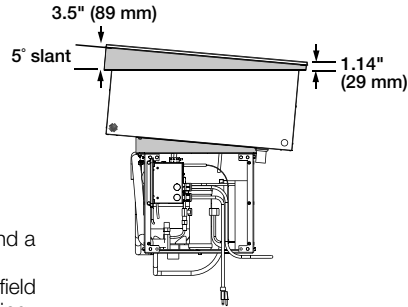

## ALL MODELS - False Bottom Accessory 1-part, 2- or 3-part, depending on pan size

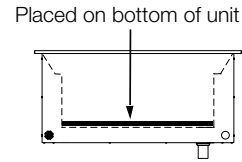

## Model CWBR-1, CWBX-1

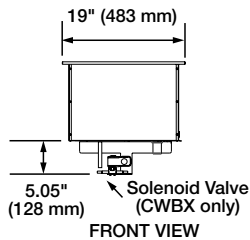

## Model CWBR-, CWBX-2

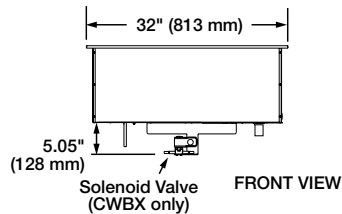

## Model CWBR-, CWBX-3

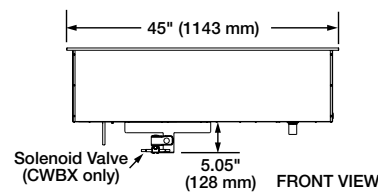

## Model CWBR-, CWBX-4

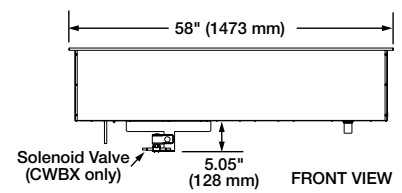

## Model CWBR-5, CWBX-5

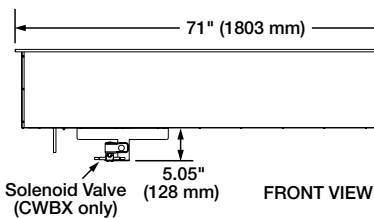

## Model CWBR-6, CWBX-6

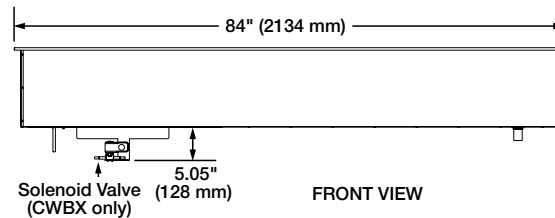

## All Models Side View

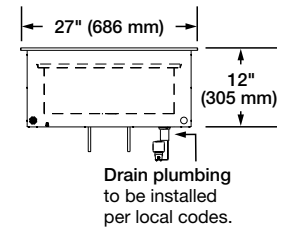

## All Models Control Panel

May be field mounted up to 16' (4.9 meters) from unit

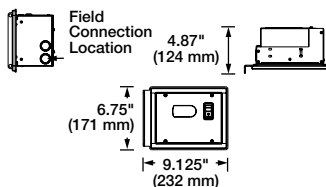

## Model CWBR only Condensing Unit

May be field mounted up to 50' (15.24 meters) from unit

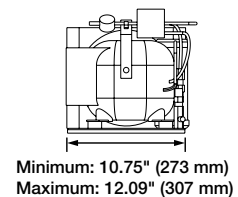
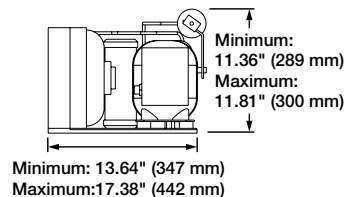



# Remote Refrigerated Drop-In Wells

Models: CWBR-1, -2, -3, -4, -5, -6, CWBX-1, -2, -3, -4, -5, -6

## Cutout Dimensions for Remote Refrigerated Drop-In Wells

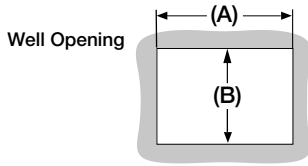

Model	Minimum Width (A)	Maximum Width (A)	Minimum Depth (B)	Maximum Depth (B)
CWBR-1, CWBX-1	17.125" (435 mm)	18" (457 mm)	25.19" (640 mm)	26" (660 mm)
CWBR-2, CWBX-2	30.125" (765 mm)	31" (787 mm)	25.19" (640 mm)	26" (660 mm)
CWBR-3, CWBX-3	43.125" (1095 mm)	44" (1118 mm)	25.19" (640 mm)	26" (660 mm)
CWBR-4, CWBX-4	56.125" (1426 mm)	57" (1448 mm)	25.19" (640 mm)	26" (660 mm)
CWBR-5, CWBX-5	69.125" (1756 mm)	70" (1778 mm)	25.19" (640 mm)	26" (660 mm)
CWBR-6, CWBX-6	82.125" (2086 mm)	83" (2108 mm)	25.19" (640 mm)	26" (660 mm)

## SPECIFICATIONS

### Drop-In Full-Size Models - with Condensing Unit and Remote Control Panel

The shaded areas contain electrical information for International models

Model†	Dimensions (Width x Depth x Height)	Voltage	HP Compressor Size	Hz	Watts	Amps	Phase	Ship Weight
CWBR-1	19" x 27" x 12" (483 x 686 x 305 mm)	120	1/4	60	804	6.7	Single	131 lbs. (59 kg)
		220/230/240	1/3	50	616/667/744	2.8/2.9/3.1		
				60	686/749/816	3.1/3.3/3.4		
CWBR-2	32" x 27" x 12" (813 x 686 x 305 mm)	120	1/4	60	804	6.7		
		220/230/240	1/3	50	616/667/744	2.8/2.9/3.1		
				60	686/749/816	3.1/3.3/3.4		
CWBR-3	45" x 27" x 12" (1143 x 686 x 305 mm)	120	1/4	60	804	6.7		
		220/230/240	1/3	50	616/667/744	2.8/2.9/3.1		
				60	686/749/816	3.1/3.3/3.4		
CWBR-4	58" x 27" x 12" (1473 x 686 x 305 mm)	120	1/3	60	1044	8.7		
		220/230/240	3/8	50	807/882/960	3.7/3.8/4.0		
			1/3	60	686/749/816	3.1/3.3/3.4		
CWBR-5	71" x 27" x 12" (1803 x 686 x 305 mm)	120	1/2	60	1380	11.5		
		220/230/240		50	1190/1300/1416	5.4/5.7/5.9		
				60	1210/1322/1440	5.5/5.8/6.0		
CWBR-6	84" x 27" x 12" (2134 x 686 x 305 mm)	120	1/2	60	1380	11.5		
		220/230/240		50	1190/1300/1416	5.4/5.7/5.9		
				60	1210/1322/1440	5.5/5.8/6.0		

† Models shipped with condensing unit, electronic temperature control and TXV valve (all shipped loose).



# Remote Refrigerated Drop-In Wells

Models: CWBR-1, -2, -3, -4, -5, -6, CWBX-1, -2, -3, -4, -5, -6

## SPECIFICATIONS

### Drop-In Wells Full-Size Models - with Remote Control Panel (without a Condensing Unit)

The shaded areas contain electrical information for International models

Model†	Dimensions Δ (Width x Depth x Height)	Voltage	Load/ BTU/H	HZ	Ship Weight
CWBX-1	19" x 27" x 17" (483 x 686 x 305 mm)	120	330	60	94 lbs (43 kg)
		220/230/240		50/60	
CWBX-2	32" x 27" x 17" (813 x 686 x 305 mm)	120	630	60	123 lbs. (56 kg)
		220/230/240		50/60	
CWBX-3	45" x 27" x 17" (1143 x 686 x 305 mm)	120	930	60	150 lbs (68 kg)
		220/230/240		50/60	
CWBX-4	58" x 27" x 17" (1473 x 686 x 305 mm)	120	1230	60	176 lbs. (80 kg)
		220/230/240		50	
				60	
CWBX-5	71" x 27" x 17" (1803 x 686 x 305 mm)	120	1530	60	211 lbs. (96 kg)
		220/230/240		50/60	
CWBX-6	84" x 27" x 17" (2134 x 686 x 305 mm)	120	1830	60	250 lbs. (113 kg)
		220/230/240		50/60	

† Models shipped with electronic temperature control and TXV valve (all shipped loose). CWBX units include a solenoid valve attached to well.  
 Δ For CWBX models only, add 5.05" (128 mm) to the height for the attached solenoid valve.

## PRODUCT SPECS

### Remote Refrigerated Drop-In Wells

The NSF 7 approved Remote Refrigerated Drop-In Full-Size Rectangular Well shall be a Model ... as manufactured by the Hatco Corporation, Milwaukee, WI 53234 U.S.A.

The Refrigerated Drop-in Well shall be rated at ... watts, ... volts, ... hp, and be ... inches (millimeters) in overall width and be ... inches (millimeters) in overall depth. It shall utilize R-404A refrigerant and consist of an aluminized steel housing with a stainless bezel, an electronic temperature control, pan support bars for full-size pans and with or

without a condensing unit (compressor, sight glass, service valves, receiver and dryer).

Accessories may include pan support bars, false bottom, trivets and stainless steel food pans.

Warranty consists of 24/7 parts and service assistance (U.S. and Canada only).

**HATCO CORPORATION** | P.O. Box 340500 Milwaukee, WI 53234-0500 U.S.A.  
 (800) 558-0607 | (414) 671-6350 | www.hatcocorp.com | support@hatcocorp.com